

 **PaybyOnline.com**



ABOUT PAYBYONLINE.COM

PaybyOnline.com is a multipurpose cloud based platform for selling, distributing, reselling and buying products and services. End User can buy available services from any part of the world using our platform as payment gateway. Any service providers can easily be a merchant simply by registering to sell any products and services. Besides Merchant and User, anyone can become Reseller or Super Reseller to sell and distribute merchant services to end users with a commission earning.





PAYMENT GATEWAY

PaybyOnline acts as a “Payment as a Service(PAAS)” platform that supports several Credit/ Debit cards, international payment gateways, global banks and/ or country wise local banks and financial institutions for Online, ATM Banking.

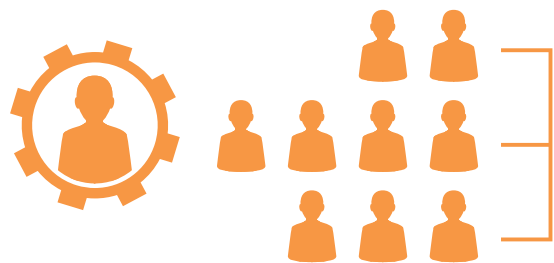

As a user, there will be eWallet system can be deposited from any of local or international banks or other payment gateways that linked with the system, this can be used to pay to merchants or deposit back to bank. As a merchant, there is a virtual payment page auto designed by system that lets your customer pay through it or if one is running online ecommerce site, simply use our API and integrate in your e-commerce payment page and your customer will have easy payment. You as a Merchant will have your wallet deposited after your customer pays.

PaybyOnline.com can also be used for any recurring payments or subscription, We have a system of auto notification to customer which will help customer pay on time without remembering day to pay and can avoid penalty charges.

Clearing bills, recharging Mobile was never so easy & fast..

Check PaybyOnline & realize yourself..



BUY & SELL

Registered User can buy any products or services from the merchants that are registered with PaybyOnline. Such services may include Utility bills, medical payment, movie ticket booking, airline ticketing etc. One can also have several events that can be booked via PaybyOnline A Merchant can send invoice to customers and let his customer make payment through it.



Being a global platform, PaybyOnline allows to sell products or services in another part of world besides merchant's own country while as a user, a user from one country can get access and buy a product and services of another country.

- **Pay Bills**
You can pay all your school, medical, and all other pending bills instantly from anywhere and at any time
- **Online Buy & sell**
With various facilities you will be able to buy and sell any goods on paybyonline.com
- **Make Bookings**
You can easily make any booking like ticket, hotel rooms etc..
- **Credit Card Payment**
You can also pay your credit cards without any tedious process



ONLINE REMITTANCE

PaybyOnline supports many countries and currency for sending and receiving money. Either you are sending money for your family or friend or paying for any service, PaybyOnline's quick transfer service will help you job done fast and easily in a very minimal cost.



PaybyOnline has partnered with several payment gateway providers, banks and financial institutions for easy delivery to receiver. Receiver doesn't need to go to Agents to pick up money rather your money will be deposited in your defined banks or payment gateway. Moreover, it is a GLOBAL system that you can send from one corner of world to another corner in different country that we are currently in operation without any hassle.

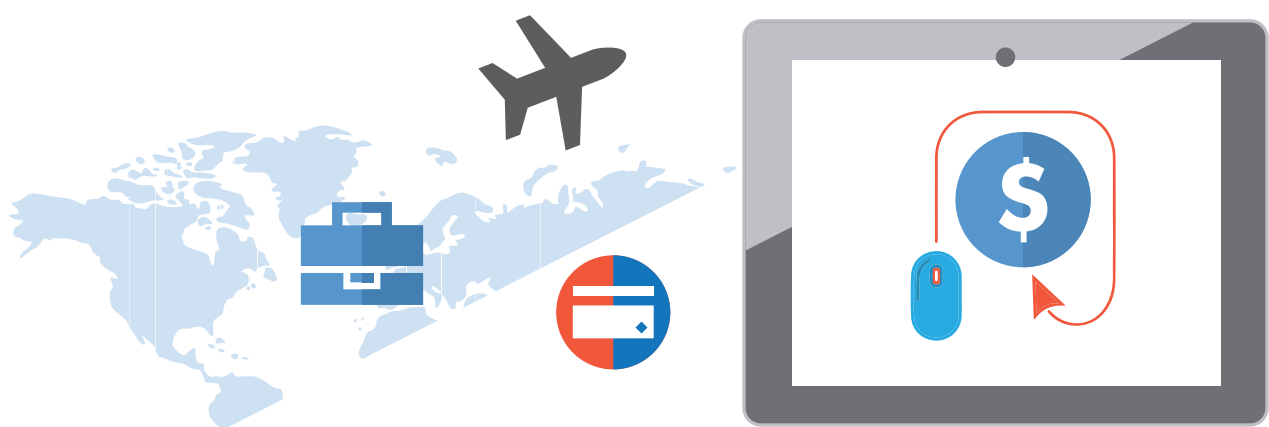

Send or Receive money from and to any part of world.

END USER



End User is a platform for general user. As a general user, one can buy any services registered with PaybyOnline with a very good discounted price. We intent to provide a possible discount in all merchant's services

No more waiting in the queue to settle bills. No more keeping track of the paid and unpaid bills. No more waiting to go to convenient stores to get a recharge card. You can easily transfer funds anywhere, anytime to any part of the world. All transactions are highly secured so you need not worry or think twice before using our payment portals. Multiple currency transactions are accepted which helps you make payments to one country from any other part of the world.



MERCHANT

A Merchant of PaybyOnline.com can sell services to PaybyOnline customers online using the portal. Merchant may have limited banks and limited payment collection outlet but with the help of PaybyOnline customer of any Merchant can pay from any country, any currency, any banks. Using Payment gateway of PaybyOnline, customer from any part of world pays to any merchant associated with PaybyOnline.



There is a very simple method to be merchant, User can add account as a Merchant, complete settings, add products and services, define location or country where to sell and then design his own page how it is to be viewable to his end users and soon after verification merchant's own page can be viewable by End users. Merchant can choose several methods of choosing platform including sub domain with PaybyOnline or to integrate the page with your own domain using our API.

Merchant not only get platform to sell products but also will have platform to marketing services. Merchant can grow his network through social sites, Gmail, Hotmail, Contacts with the tools provided by PaybyOnline.

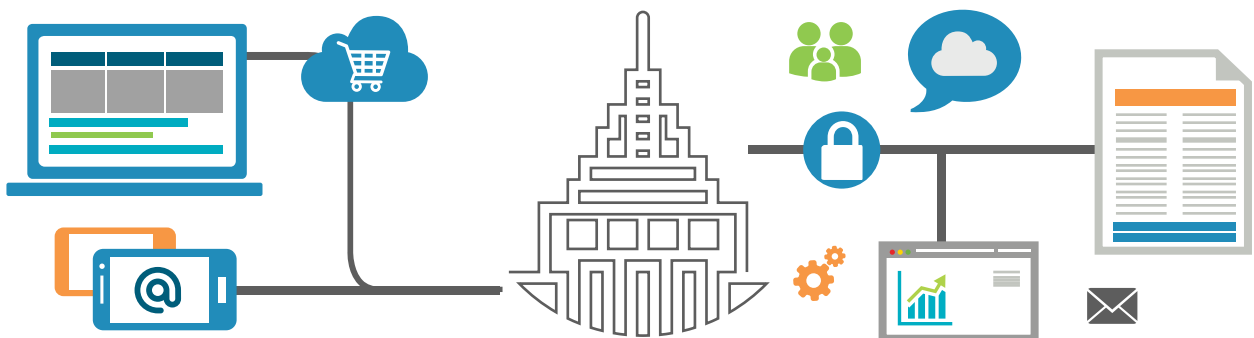

RESELLER



PaybyOnline.com could be a perfect platform for a good earning to a small business or retailer or doing freelance small business activities. One can simply register as Reseller and sell the products or services of the merchants that are enlisted in PaybyOnline and start earning. There are several commission packages set by each merchants. Resellers will be entitled to get commission soon after you begin selling. So with a very small or no investment, resellers can get access to several merchant products and services and earn money.

Are you a small business or you own a small shop or you are a student seeking some good income?? Come.. Join PaybyOnline.. Become Reseller... and Start Earning..



SUPER RESELLER

Become Super Reseller..
 Market with your own
 Brand.. Grow your
 Network and make a
 good Income..

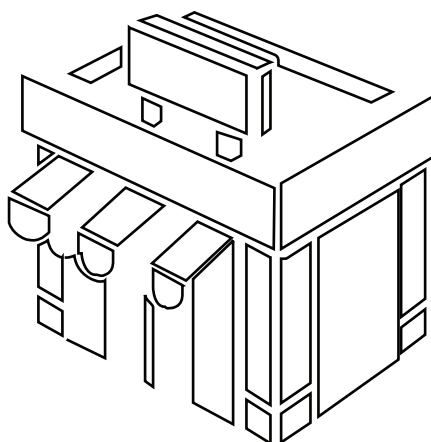

Super Reseller can be regarded as Distributor or an apex level of Reseller who holds multi Users, Resellers and different tiers of Super Resellers. Being a Super Reseller one can create numerous such user types and as those users/ resellers make any transaction, Super reseller will have his e-wallet filled up with defined commissions. With a good performance, Super Reseller will be promoted to higher level of tiers, the higher the tier is, the more level of sub Super Reseller he can create and get hold of lots of users. The more such users, Super Reseller will have more transactions and can make earning in each transaction they make.

Besides we have Exclusive Super Reseller System in which Super Reseller will be given exclusive user right for a particular region and any user or reseller registered in that region will automatically be under such exclusive Super Resellers.

If one wants to make platform with their own Brand, there is Co-Branding system with which one can have his own domain and brand for marketing. Users or resellers will know the brand belongs to such Super Reseller and can set his own discount or commission, Deal and Offers and Reward points. Also we provide API to developer and with this help any once can integrate with their application as they want.

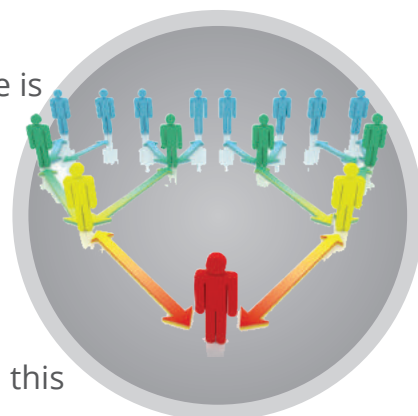



Deal, Discount & Offers

User can get Discount in every steps while buying any service or while making Wallet deposit. Many merchants offer much discounts while buying from PaybyOnline than through other ways. Also with Deal or Promo Code System, one will be entitled to get additional discounts on such deals and promotion offers.

Reward Point System

There are several Reward Point packages available as per the user's country. One can start getting rewards soon after registration or when one log on.. User will earn much more when start buying things. Even more, User will get reward when making partner and will even be getting reward point as partner start buying.



Classification

User can make his own tags to make grouping of merchants or products or services and make sorting of favorite products or services.

There are also easy and flexible search criteria to search merchants and their services based on product category, location, product segments etc.



Report & MIS

There are several useful report designed aesthetically for each role type whether you are User or Reseller or Super Reseller. With the dynamic reporting facility designed in tabular and graphical style, you will be getting any required information instantly.



Global System

PaybyOnline is global platform that you can sell your products or services to many countries one want in their currency. User from any part of the world thus be able to buy services from another part of world paying through their own currency.



Offline System

The system can be used as Offline system where user can register, make payment or recharge without internet connectivity and using SMS Connectivity. User doesn't need to remember syntax as in traditional system rather there is mobile Apps in which user can do activity with GUI tools and system will send SMS for server connectivity. However for users without having smart phone can also use syntax system for activity. With this tool, even in remote location or place where there is no internet connectivity, user can easily use the system.



Security System

The system incorporates Multi Tier Authentication which can be used during Login, Wallet deposit, Payment or Recharge. There is Single or Multiple Authentication policy can be applied and authentication can be made through SMS, Email or Apps Notification, Google Authentication. Also there is Security Code System for user operating from Mobile. This is one extra layer of security where user need to put extra pass code or security code for doing any activities.



We have adopted all security measures and compliance security standards to make system Full Proof & Secured..

Reconciliation and Audit Tools

The system incorporates tools to reconcile with your purchase, sales, banks or merchant. You can track logs of every transaction for Audit purpose with detail information. Also you can make periodical closing and make settlement with your banks, dealers, merchant etc..

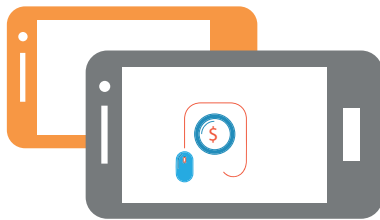

Mobile Compatibility

The application can be run as web based on in mobile based in all OS including Android, IOS and Windows.

User Verification Tools

Verification of User can be done through Email or Mobile No Verification. Also there is KYC Tools and User need to send required documents for verification (viz. Citizenship, Driving License, Passport or any other identification as per the need of your country's regulator.



PLATFORM BENEFITS



PaybyOnline has some unique features that can be a good benefit for all user roles. Whatever your profession or whatever business you are engaged in. PaybyOnline helps you to boost your income as well.

Benefits to Merchant



- customer can easily use any merchant services and make required payment without going to Merchant site or merchant's premise.
- As more products and services will be added in future from other countries, both of customers will get added benefits.
- The Merchant will be highlighted and advertised in all where we do our product advertisement.
- As the Online payment system is getting more popular, this will be beneficial for all customer, Merchant and service provider.

BENEFITS TO SUPER RESELLERS



- Co Branding : Use this feature to let you customer recognize with your own brand and you can promote with your brand to your customer. Customers will be able to do all that business just visiting your site.
- Multi Tier of Distribution : As our system has architect of Multi Tier Distribution, you can use this nice features to grow your network. For e.g. you can set a tier for your field staffs and they can also earn while their customer buy services from them. Also you can set tier for location wise distribution and then after another tier for field staffs and all those tier level will earn while someone buy things.
- Mobile Apps with your own Brand : Let your own Logo and Icon be visible to your customer's Mobile or Tablets. You can have your own brand apps and your customers can download it from play store with your own brand.
- Merchant of you own : You can also attract local Merchants including local business, schools, colleges etc. So your customer from all part can get benefit from a single platform.
- Joint Promotion : We treat Super Reseller as our Partner and thus you will be highlighted and advertised in all where we do our product advertisement.
- Grow Network Tools : There is grow network tools in the software which will easily help you to expand your network and promote your brand and customer base.
- Web Services (Web Registration/ Designing/ Hosting) : We will also provide you all web services that will help your business grow including registering your web site, hosting and integration with PaybyOnline.
- Integration with your Core Software : If required, we can integrate with your core software to share customers and make wallet deposit and withdrawal.

BENEFITS TO INTEGRATING PAYMENT GATEWAY

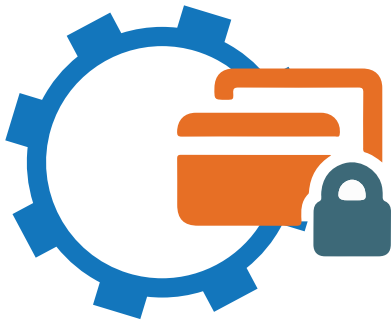

- Our customer having account with any integrating Financial Institutions can easily use merchant services and make required payment.
- The partner Bank or Payment Aggregators will be highlighted and advertised in all our media campaign

BENEFITS TO RESELLER



- Reseller can be anyone from a small shop to an individual who can make a good earning through selling merchant services
- Reseller with a very less investment can be able to sell all available merchant services in a system with a good commission

PaybyOnline provides benefits to all..
Now Everyone can do Business..

BENEFITS TO END USERS



- Customer can easily make payment to all merchant services from our application itself without going anywhere.
- Customer will save time without going physically anywhere and even without going to any other site for payment.
- Customer will have convenient way of payment.
- For any recurring payment or subscription, we have a system of auto notification to customer which will help customer pay on time and will be beneficial for Bank, Service provider and customer.

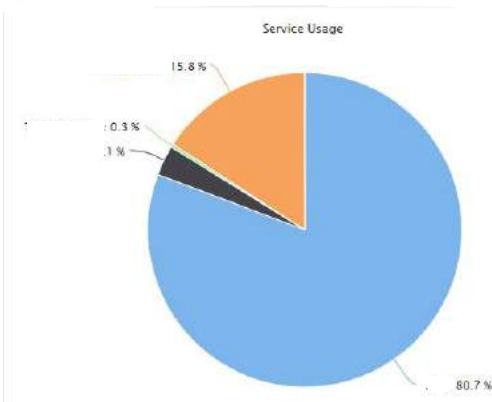

You can buy, You can Sell, You can Resell, You can Distribute..
All in one Single Platform..



PaybyOnline.com is an online pay service introduced to make life much more easier and simpler. So now you can just sit back, relax and pay services or easy recharge mobile by just click for your mouse.



